

Operating Instructions FOR TBM58PCTS-LI HYDRAULIC CUTTING TOOL

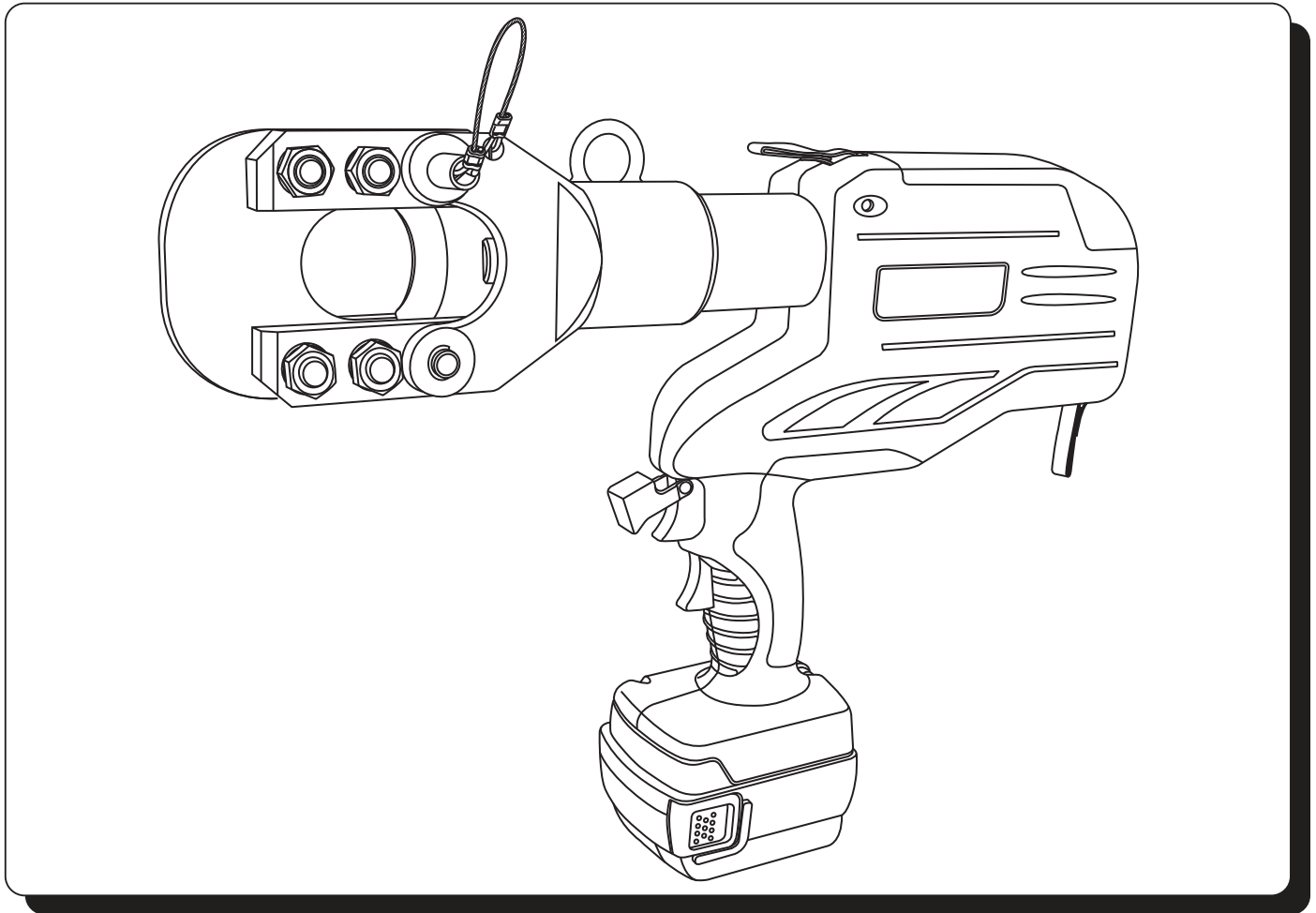

Table of Contents

| | Page | | Page |
|--|----------|---|----------|
| 1.0 GENERAL INFORMATION..... | 2 | 3.4 Switch Operations..... | 4 |
| 1.1 Safety Rules..... | 2 | 3.5 Cutting Operation..... | 5 |
| 1.2 Features..... | 2 | 3.6 Maintenance & Operation..... | 5 |
| 1.3 Specifications..... | 2 | 3.7 Trouble Shooting..... | 5 |
| 2.0 Parts & Accessories..... | 3 | 4.0 Important Operation Precautions..... | 6 |
| 2.1 Hydraulic Cutting Tool..... | 3 | 4.1 Precautions for the Cutting Tool..... | 6 |
| 2.2 Battery..... | 3 | 4.2 Precautions for the Battery..... | 6 |
| 2.3 Charger..... | 3 | 4.3 Precautions for the Charger..... | 6 |
| 2.4 Carrying Case..... | 3 | 5.0 Parts Breakdown..... | 7 |
| 3.0 Operating Instructions..... | 4 | 5.1 Parts Diagram..... | 7 |
| 3.1 Charging the Battery..... | 4 | 5.2 Parts List..... | 8 |
| 3.2 Attaching & Detaching the Battery..... | 4 | | |
| 3.3 Cutting Cycles..... | 4 | | |



IMPORTANT: Read and understand all of the instructions and safety information in this manual before operating or servicing this tool.

1.0

GENERAL INFORMATION

1.1 SAFETY RULES

1. **BE FAMILIAR WITH YOUR TOOL.**
Read the instruction manual. Become aware of its proper usage as well as the potential hazards.
2. **KEEP WORK AREA CLEAN AND WELL LIGHTED.**
Poor lighting and cluttered areas invite accidents.
3. **USE SAFETY GLASSES.**
4. **MAINTAIN TOOL WITH CARE.**
Keep tool in good condition at all times. Keep it clean for best and safest performance.
5. **DON'T OVER-REACH.**
Keep proper footing and balance at all times.
6. **NEVER ATTEMPT TO CUT A "HOT" LINE.**
Never assume the power is OFF! Determine beforehand if any electrical hazards could exist when making a cut to a line or wire.
7. **KEEP FINGERS AND OTHER BODY PARTS AWAY FROM CUTTING BLADES & MOVING PARTS.**

WARNING



Tools are **NOT** insulated for use on or near energized conductors. Use of these tools near energized conductors may lead to electrical shock, causing severe injury or death. **DO NOT** use these tools near energized conductors without adequately insulating operator and surroundings.

WARNING



Pinch point hazard. Cutting Blades at high force can cause severe personal injury. Keep all body parts away from moving parts of the tool during operation.

1.2 FEATURES

- Fully automatic, self-contained power tool.
- Removable battery cartridge - simply change the cartridge for continuous use.
- One handed operation - control ram advancement and retraction with one hand.
- Two stage rapid advance ram.
- Overload bypass protection.

1.3 SPECIFICATIONS

HYDRAULIC CUTTING TOOL:

TBM58PCTS-LI

| | |
|---------------------|--|
| Drive Unit: | 14.4V DC Motor |
| Dimensions: | 17.5"L x 2.5"W x 13"H |
| Weight: | 14.6 lbs. with battery |
| Capacities: | Wire Rope 3/4" Rebar 5/8" Ground Rod 5/8" ACSR 1-1/2" Cu/AL Cable 1-1/2" |
| Jaw Opening: | 1.65" |

BATTERY:

144-BAT-LI

| | |
|-----------------------|---|
| Battery Type: | Sealed Lithium Ion |
| Voltage: | 14.4V DC |
| Dimensions: | 4.2"L x 3.3W x 2.6H |
| Capacities: | 3.0Ah |
| Weight: | 1.2 lbs. |
| Charging time: | 25 min. 80% Capacity 45 min. 100% Capacity |

CHARGER:

144-CHR-LI

| | |
|-----------------------|-----------------------------|
| Input Voltage: | 120 - 240 V AC Single Phase |
| Dimensions: | 9"L x 5.7W x 3.2H |
| Weight: | 3.5 lbs. |

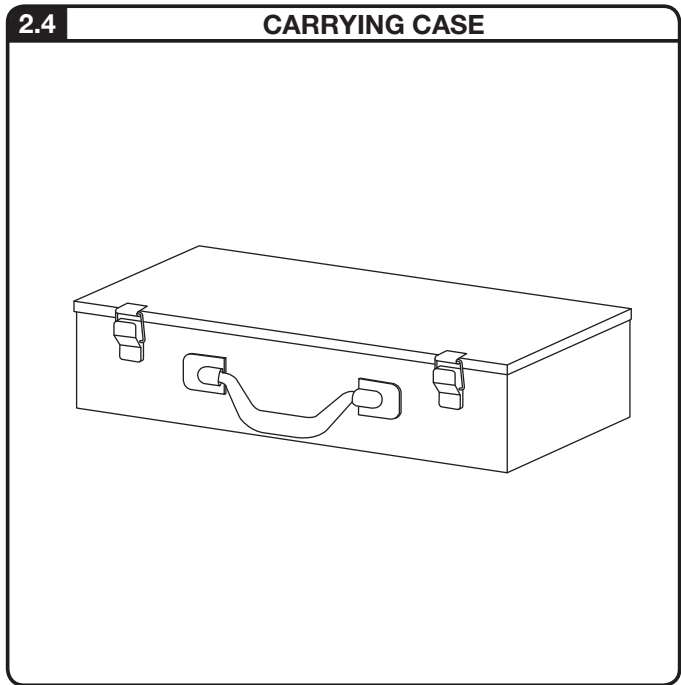
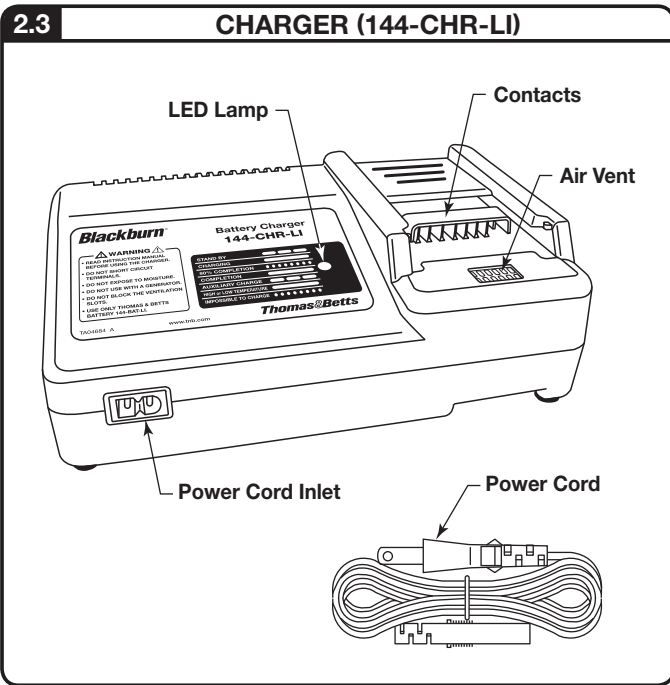
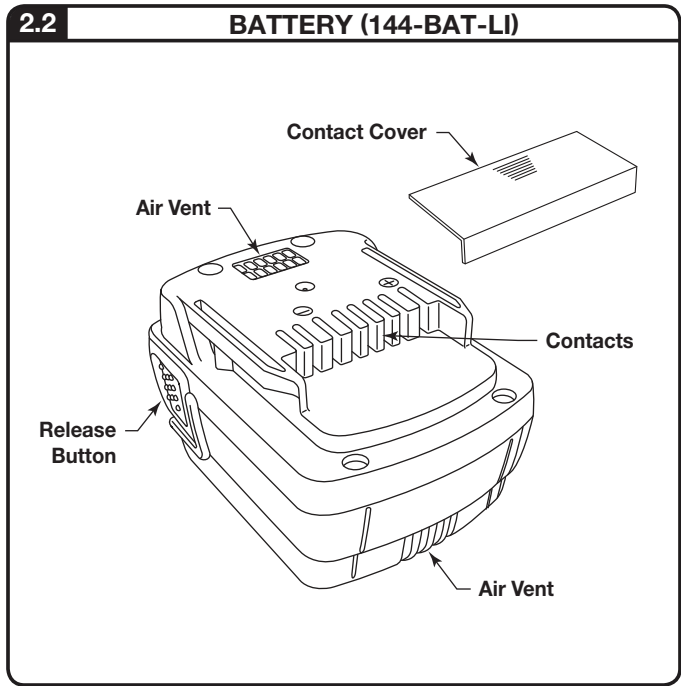
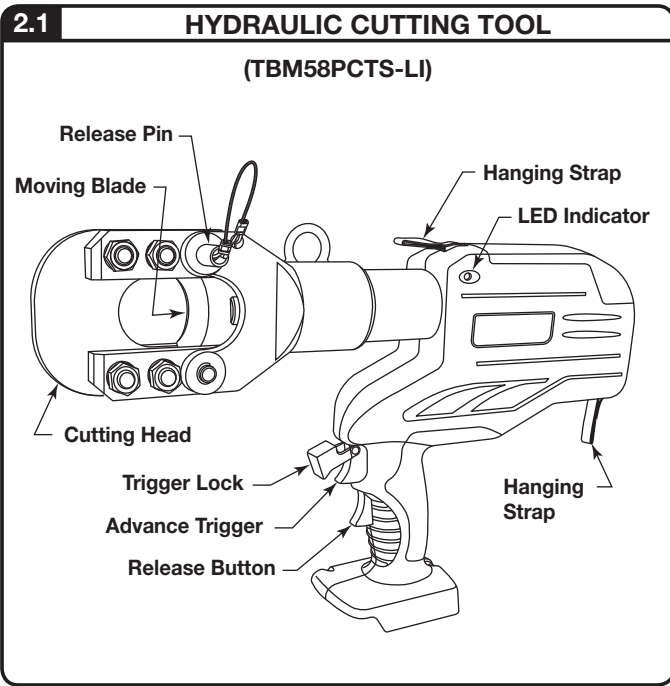

3.1

CHARGING THE BATTERY

1. Connect the power cord to the Charger 144-CHR-LI and to an AC outlet. The LED Lamp blinks in Red [STAND BY]
NOTE: The rated input voltage for this unit is 100V-240V. Use of voltages over 260V will result in damage to the charger.
2. Insert the Battery firmly into the charger.
The LED Lamp lights in green [CHARGING].
NOTE: Do not short-circuit the Charger by placing foreign materials in the contacts on Charger, as this will damage the Charger.
3. Charging takes approximately 25 minutes (80% capacity) and 45 minutes (100% capacity).
When charging is finished, the LED Lamp lights in orange [COMPLETION].
NOTE: If the LED Lamp displays solid red [HIGH TEMPERATURE], remove the Battery from the Charger and allow it to cool down before trying to charge it again.
4. When the battery will no longer charge or hold a charge, the LED Lamp blinks quickly in red [IMPOSSIBLE TO CHARGE].
5. When the charger is out of order, the LED Lamp does not light up even if AC power is supplied.
NOTE: Do not power the Charger with a portable generator.

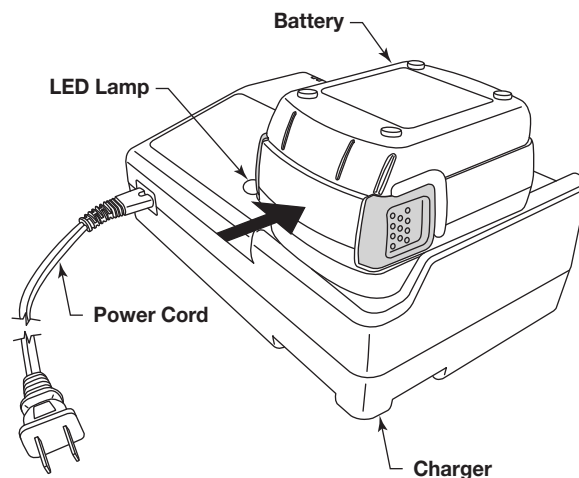

3.2 ATTACHING & DETACHING THE BATTERY PACK

1. To attach the Battery, slide it into the base of the Tool until it stops and the Latches engage.
2. After inserting the Battery, check that it is securely in place by pulling it gently without pressing the Latches.
3. To detach the Battery, pull out the Battery while pressing the Latches.

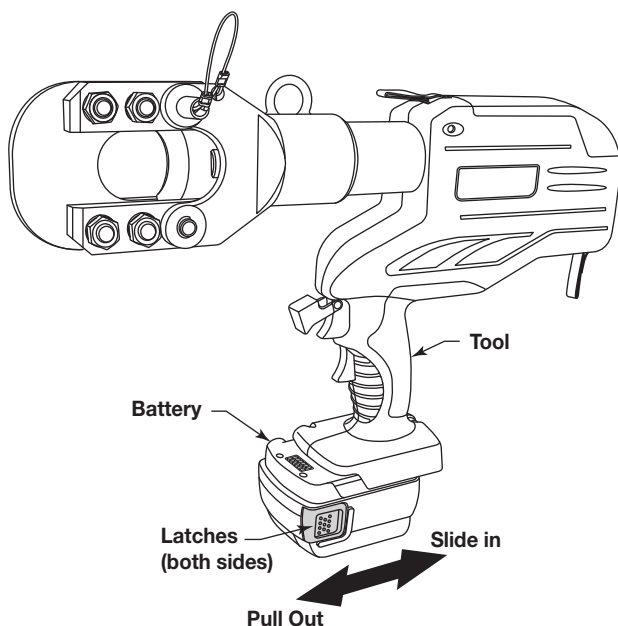

3.3

CUTTING CYCLES

This guide indicates the number of cutting cycles that the TBM58PCTS-LI can be expected to perform when the battery is fully charged. These figures are approximate and will vary according to the charging and other operating conditions, such as temperature, humidity, and battery condition.

| MATERIAL | AVERAGE CUTS PER CHARGE 144-BAT-LI |
|---------------------------|---------------------------------------|
| 3/4" Wire Rope | 100 |
| 5/8" Rebar and Ground Rod | 75 |
| 3/4" ACSR | 75 |

3.4

SWITCH OPERATIONS

1. The blade advances when the Trigger is depressed and stops when the Trigger is released. To access the Trigger, swing the Trigger Lock upward. When not in use, lower the Trigger Lock to prevent inadvertent tool actuation.
2. To retract the blade, depress the Release Button. The blade continues to retract while the Release Button is depressed.

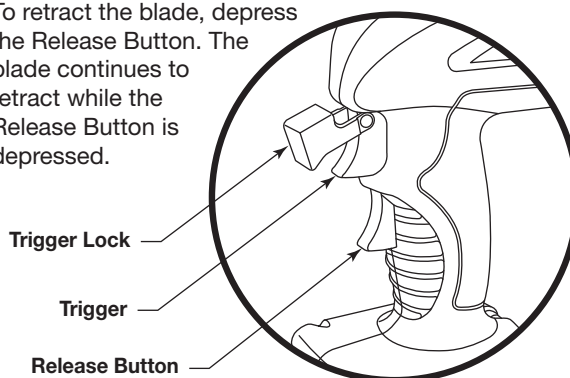

3.5

CUTTING OPERATION

1. Retract the Moving Blade fully by depressing the release button.
2. Make sure the material being cut is within the specified capacity of the tool.
3. Insert the material between the Cutter Head and Moving Blade. The Cutting Head can be opened to insert the material by removing the Cutting Head Latch Pin and pivoting the Cutting Head open (A).
4. Close the Cutting Head and insert the Cutting Head Latch Pin securely. Always check the cutting head latch for proper engagement before continuing with the cut (A & C).

WARNING
Failure to secure the cutting head latch can result in severe tool damage and personal injury.

5. Check the material for proper alignment to the Cutting Blades. It should be at a 90° angle to the blades. Any other angle will cause the blades to spread apart and possibly break (B, C & D).
6. Advance the Moving Blade by depressing the trigger. Continue until the material is cut and the tool has bypassed, indicated by a series of clicks followed by a release in pressure. The LED indicator on either side of the tool will show GREEN when a complete cut is made and the tool has bypassed. A RED indicator light will show if the cut is incomplete due to early release of the trigger or a low battery. An ORANGE indicator will show if the battery is getting low but the cut is complete.
7. Press the release button and retract the Moving Blade.

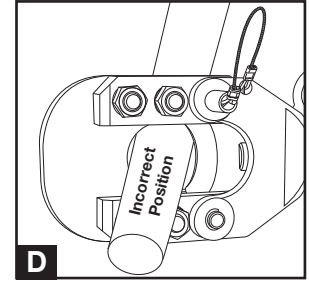
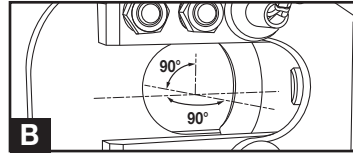
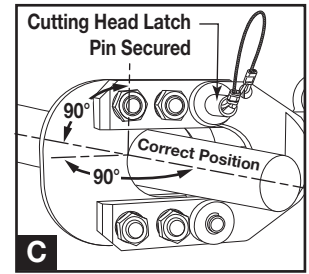
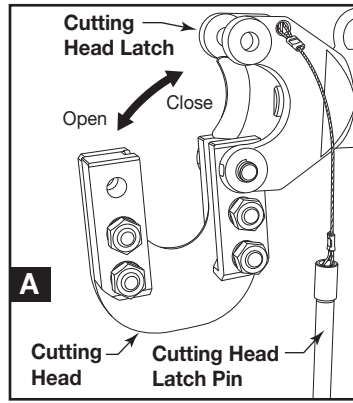

WARNING
Pinch point hazard. Cutting Blades at high force can cause severe personal injury. Keep all body parts away from moving parts of the tool during operation.

3.6

MAINTENANCE & INSPECTION

1. Very little maintenance is required to ensure that the tool is kept in good working condition.
2. To ensure smooth operation and prevent rust, store the tool in a cool dry area. Ensure that moving parts are lubricated regularly.
3. When the plastic housing becomes dirty, clean it with a soft soaped cloth.
4. Dust, sand, and dirt are a danger for any hydraulic device. After each use, the tool should be wiped with a clean cloth taking care to remove any residue, especially close to the movable parts.
5. If the tool is maintained regularly, it should provide you with trouble free service.

NOTE: Always remove the battery pack from the unit before replacing parts or maintenance.



3.7

TROUBLE SHOOTING

| Problem | Cause | Solution |
|---|--|---|
| Charger LED lamp indicates stand by while battery is inserted. | There is dust or foreign objects lodged at the battery contacts. | Remove foreign objects. |
| The charger LED lamp indicates high or low temperatures. | The battery is too hot or cold. | Allow the cartridge to reach room temperature before continuing. |
| | The battery is not charged. | Charge the battery. |
| The motor does not operate at all. | There is dust or foreign objects lodged at the battery contacts. | Remove foreign objects. |
| | The switch is misaligned. | Check to see if switch is aligned with trigger, consult tool service. |
| | Insufficient hydraulic oil. | Consult tool service. |
| The motor runs but blade will not advance, or blade advances but will not build pressure. | Air in hydraulic system. | Hold the tool with head towards the floor to allow air to rise towards top of oil bladder. |
| | Defective hydraulic circuit. | Consult tool service. |
| The blade will not retract | Tool did not complete a full cycle and bypass. | Depress trigger and allow tool to reach full pressure and bypass, then depress release button to retract the ram. |
| | The material is jammed in cutting blades. | Depress and hold release button while prying cutting blades apart. |
| | The release button is bent or misaligned. | Consult tool service. |

4.1 PRECAUTIONS FOR CUTTING TOOL

1. Select the appropriate materials to be cut.

 **WARNING** 

Cutting materials other than those specified will result in severe tool damage and may cause personal injury.

2. Always cut the material at 90° to the blade. Trying to cut at any other angle will cause the blades to spread apart and possibly break.
3. Always point the tool away from other people.
4. If the tool is stored for an extended period at a temperature of less than 25° F (-5° C), the tool should be allowed to return to room temperature to ensure smooth operation. Use the tool only after it has been at room temperature for 1 hour.
5. Do not drop the tool. Dropping the tool may damage the hydraulic circuit and cause malfunctions.
6. Keep the head and ram clean and free of debris. Solvents can be used to clean the head but should not be used on the plastic body. Use soap & water to clean the body.

4.2 PRECAUTIONS FOR THE BATTERY PACK

1. Do not short circuit the contacts or expose the battery to water, oil or solvents.
2. Do not disassemble or attempt to repair the battery or dispose of in a fire.
3. Do not drop or otherwise abuse the battery.
4. Do not leave the battery in locations where it will be exposed to a temperature greater than 104 degrees F (40 degrees C) for an extended period.
5. The battery has a limited life. When the capacity becomes about 1/2 that of the original capacity, the battery should be replaced.
6. If the battery is stored without being charged, natural drainage will cause the power to be reduced. The battery should be charged every 3 months if not in use regularly.

4.3 PRECAUTIONS FOR THE CHARGER

1. The LED lamp lights up green and remains lit when the unit starts charging a battery. The indicator turns orange when charging is completed.
2. This unit is for charging battery 144-BAT-LI only. Do not use the charger for any other devices.
3. Allow battery cartridges to cool before charging. Allow at least 15 minutes between charges when charging several batteries in succession.
4. Charge batteries at an ambient temperature of 50-95 degrees F (10-35 degrees C). Charging time is approximately 25 minutes for 80% capacity and 45 minutes for 100% capacity.
5. Never short circuit the output contacts.
6. Do not expose the charger to water, oil or solvents.
7. Do not disassemble, modify, drop or otherwise abuse the charger.

WARRANTY: Thomas & Betts sells this product with the understanding that the user will perform all necessary tests to determine the suitability of this product for the user's intended application. Thomas & Betts warrants that this product will be free from defects in materials and workmanship for the period stated on the enclosed warranty card. Upon prompt notification of any warranted defect, Thomas & Betts will, at its option, repair or replace the defective product. Misuse, misapplication or modification of Thomas & Betts products immediately voids all warranties.

Limitations and Exclusions: THE ABOVE WARRANTY IS THE SOLE WARRANTY CONCERNING THIS PRODUCT, AND IS IN LIEU OF ALL OTHER WARRANTIES EXPRESS OR IMPLIED, INCLUDING BUT NOT LIMITED TO ANY IMPLIED WARRANTY OF MERCHANTABILITY OR FITNESS FOR A PARTICULAR PURPOSE, WHICH ARE SPECIFICALLY DISCLAIMED. LIABILITY FOR BREACH OF THE ABOVE WARRANTY IS LIMITED TO COST OF REPAIR OR REPLACEMENT OF THE PRODUCT, AND UNDER NO CIRCUMSTANCES WILL THOMAS & BETTS BE LIABLE FOR ANY INDIRECT, SPECIAL, INCIDENTAL OR CONSEQUENTIAL DAMAGES.

